

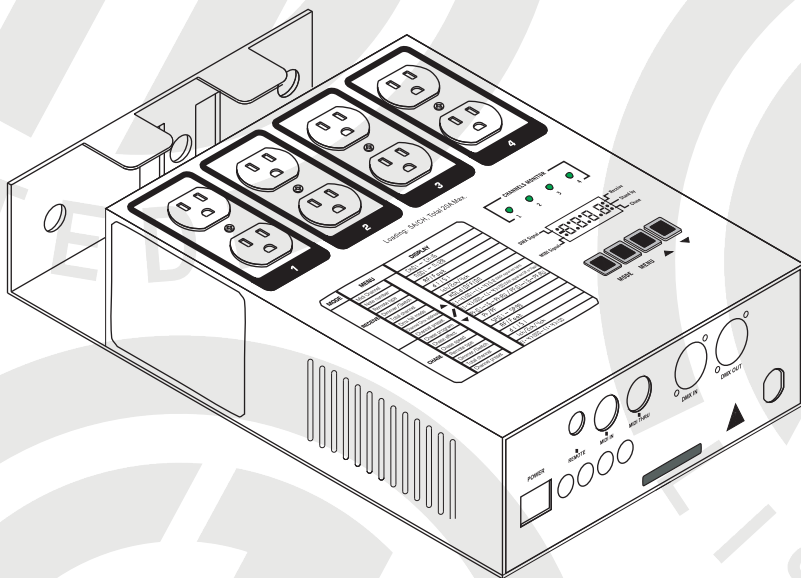

CYBER PAK



User Instructions

www.elationlighting.com

©2022 **ELATION PROFESSIONAL** all rights reserved. Information, specifications, diagrams, images, and instructions herein are subject to change without notice. ELATION PROFESSIONAL logo and identifying product names and numbers herein are trademarks of ELATION PROFESSIONAL. Copyright protection claimed includes all forms and matters of copyrightable materials and information now allowed by statutory or judicial law or hereinafter granted. Product names used in this document may be trademarks or registered trademarks of their respective companies and are hereby acknowledged. All non-ELATION brands and product names are trademarks or registered trademarks of their respective companies.

ELATION PROFESSIONAL and all affiliated companies hereby disclaim any and all liabilities for property, equipment, building, and electrical damages, injuries to any persons, and direct or indirect economic loss associated with the use or reliance of any information contained within this document, and/or as a result of the improper, unsafe, insufficient and negligent assembly, installation, rigging, and operation of this product.

Elation Professional USA | 6122 S. Eastern Ave. | Los Angeles, CA. 90040

323-582-3322 | 323-832-9142 fax | www.elationlighting.com | info@elationlighting.com

Elation Professional B.V. | Junostraat 2 | 6468 EW Kerkrade, The Netherlands

+31 45 546 85 66 | +31 45 546 85 96 fax | www.elationlighting.eu | info@elationlighting.eu

D O C U M E N T V E R S I O N



Please check www.elationlighting.com for the latest revision/update of this manual.

CUSTOMER SUPPORT

Elation Professional® provides a customer support line, to provide set up help and to answer any question should you encounter problems during your set up or initial operation. You may also visit us on the web at www.elationlighting.com for any comments or suggestions. For service related issue please contact Elation Professional®.

ELATION SERVICE USA - Monday - Friday 8:00am to 5:00pm PST

Voice: 323-582-3322

Fax: 323-832-9142

E-mail: support@elationlighting.com

ELATION SERVICE EUROPE - Monday - Friday 08:30 to 17:00 CET

Voice: +31 45 546 85 30

Fax: +31 45 546 85 96

E-mail: support@elationlighting.eu



IMPORTANT NOTICE!

There are no user serviceable parts inside this unit. Do not attempt any repairs yourself; doing so will void your manufactures warranty. Damages resulting from modifications to this fixture and/or the disregard of safety and general user instructions found in this user manual void the manufactures warranty and are not subject to any warranty claims and/or repairs.

LIMITED WARRANTY (USA ONLY)

- A. Elation Professional hereby warrants, to the original purchaser, Elation Professional products to be free of manufacturing defects in material and workmanship for a period of two years (730 days), and Elation Professional product rechargeable batteries to be free of manufacturing defects in material and workmanship for a period of six months (180 days), from the original date of purchase. This warranty excludes discharge lamps and all product accessories. This warranty shall be valid only if the product is purchased within the United States of America, including possessions and territories. It is the owner's responsibility to establish the date and place of purchase by acceptable evidence, at the time service is sought.
- B. For warranty service, send the product only to the Elation Professional factory. All shipping charges must be pre-paid. If the requested repairs or service (including parts replacement) are within the terms of this warranty, Elation Professional will pay return shipping charges only to a designated point within the United States. If any product is sent, it must be shipped in its original package and packaging material. No accessories should be shipped with the product. If any accessories are shipped with the product, Elation Professional shall have no liability what-so-ever for loss and/or or damage to any such accessories, nor for the safe return thereof.
- C. This warranty is void if the product serial number and/or labels are altered or removed; if the product is modified in any manner which Elation Professional concludes, after inspection, affects the reliability of the product; if the product has been repaired or serviced by anyone other than the Elation Professional factory unless prior written authorization was issued to purchaser by Elation Professional; if the product is damaged because not properly maintained as set forth in the product instructions, guidelines and/or user manual.
- D. This is not a service contract, and this warranty does not include any maintenance, cleaning or periodic check-up. During the periods as specified above, Elation Professional will replace defective parts at its expense, and will absorb all expenses for warranty service and repair labor by reason of defects in material or workmanship. The sole responsibility of Elation Professional under this warranty shall be limited to the repair of the product, or replacement thereof, including parts, at the sole discretion of Elation Professional. All products covered by this warranty were manufactured after January 1, 1990, and bare identifying marks to that effect.
- E. Elation Professional reserves the right to make changes in design and/or performance improvements upon its products without any obligation to include these changes in any products theretofore manufactured.
- F. No warranty, whether expressed or implied, is given or made with respect to any accessory supplied with the products described above. Except to the extent prohibited by applicable law, all implied warranties made by Elation Professional in connection with this product, including warranties of merchantability or fitness, are limited in duration to the warranty periods set forth above. And no warranties, whether expressed or implied, including warranties of merchantability or fitness, shall apply to this product after said periods have expired. The consumer's and/or dealer's sole remedy shall be such repair or replacement as is expressly provided above; and under no circumstances shall Elation Professional be liable for any loss and/or damage, direct and/or consequential, arising out of the use of, and/or the inability to use, this product.
- G. This warranty is the only written warranty applicable to Elation Professional products and supersedes all prior warranties and written descriptions of warranty terms and conditions heretofore published.

WARRANTY RETURNS

All returned service items whether under warranty or not, must be freight pre-paid and accompany a return authorization (R.A.) number. The R.A. number must be clearly written on the outside of the return package. A brief description of the problem as well as the R.A. number must also be written down on a piece of paper and included in the shipping container. If the unit is under warranty, you must provide a copy of your proof of purchase invoice. Items returned without a R.A. number clearly marked on the outside of the package will be refused and returned at customer's expense. You may obtain a R.A. number by contacting customer support.

Contents

Features 1

General Instructions 2

1. Overview 3

1.1 Front Panel 3

1.2 Rear Panel 4

2. Operation Guide 5

2.1 Receive Mode 5

2.1.1 Receive Enable 5

2.1.2 MIDI Channel 5

2.1.3 Note Number 6

2.1.4 DMX Fail mode 7

2.1.5 Channel DMX Address 7

2.1.6 1CH./ 2CH./ 4CH. Dimmer Pack 8

2.2 Chase Mode 9

2.2.1 Chase Enable 9

2.2.2 Chase Program 9

2.2.3 Chase Effect 10

2.2.4 Chase Speed 11

2.2.5 4 Channel Chaser 11

2.3 Dimmer Pack/ Switch Pack 12

2.4 Channel Dimmer Mode 13

2.5 Remote Type 13

Technical Specifications 15

Improvement and changes to this manual, specifications and design, may be made at any time without prior notice.



5014475

Features

Thank you for your purchase. This product features include:

- 4 channel chaser with 16 built-in chase programs
- 4 channel dimmer pack with 4 individual DMX channel
- Serves as a MIDI pack to receive MIDI Note Number(001-128)
- Dimmer pack and Switch pack can be selectable
- 1,2, 4 channel dimmer pack depending on your adjustments
- Fade-in or Fade-out of the chase programs
- DMX fail allows to set HOLD/OFF/ON of output
- Remote type includes FOOT and RF control
- Power failure memory.

Every effort has been made to design dependability, reliability and comfort into each unit. New products are being designed constantly to meet the needs of both entertainment and the lighting industry. We welcome your comments about our product and services.

It is both a privilege and a pleasure serving you.

General Instructions

Please read through this operating instructions before installing or using your new product. After you have finished reading the instructions, put them away in a safe place for future reference.

Safe and Efficient Use

- This product must be grounded.
- All external wiring connections and installations should be completed by a skilled person
- Do not allow any flammable liquids, water, or metal objects enter the unit.
- Take care not to damage the power cord.
- There are no user serviceable parts inside! Refer all repairs to authorized, skilled personnel.
- In the event of a malfunction (burning smell, etc.), immediately stop operation, disconnect the power supply plug, and consult authorized service personnel.
- To prevent fire or shock hazard, do not expose this product to rain or moisture.

Product Care

- This product is intended for indoor use only.
- Provide occasional ventilation during use.
- Unplug the power plug from the sockets when not using the unit for extended period.
- Do not use the unit in places subject to excessive humidity, vibration or bumps.
- Place this unit in a stable location.
- Do not dismantle or modify the unit.

1. Overview

1.1 Front Panel

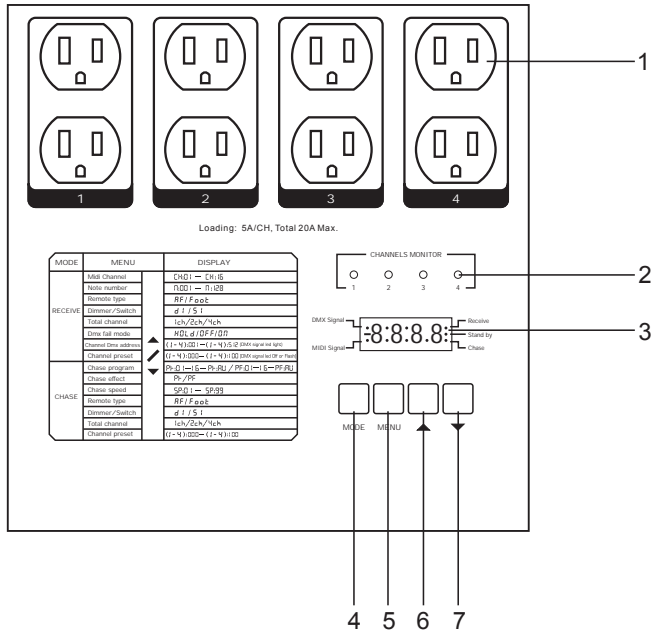

1. Channel Output: 5A/CH., Total 20A max.
2. Channel LEDs: These LEDs will indicate their relevant channel activity.
3. Segment Display: Shows the current programming and function state.
4. MODE button: This button changes the operating mode between RECEIVE and CHASE.
5. MENU button: This button activates the different functions in RECEIVE and CHASE modes.
6. UP button: This button raises the value or changes the function mode.
7. DOWN button: This button lowers the value or changes The function mode..

1. Overview

1.2 Rear Panel

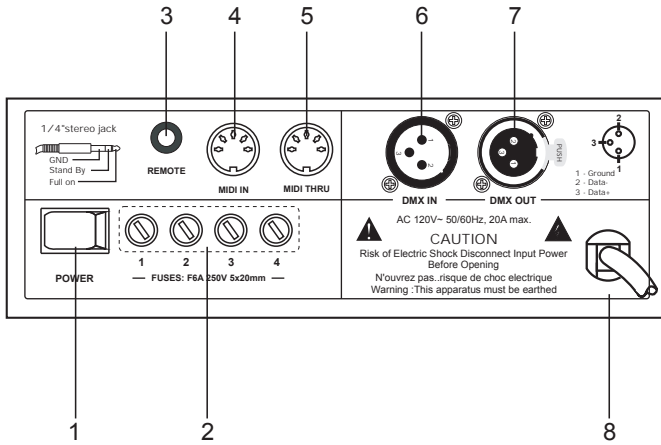

1. Power switch: This switch controls units main power.
2. Channel Fuses: Each of the four channels is protected by a 6A fuse. These fuses prevent you from overloading and damaging.
3. Remote connector: This connector is connected with a foot control or detector(sold separately).
4. MIDI IN connector: This connector is used to receive MIDI signal from a MIDI controller or MIDI sequencer.
5. MIDI THRU connector: This connector is used to transfer MIDI signal to another MIDI device.
6. DMX IN connector: This connector is used to receive DMX signal
7. DMX OUT connector: This connector is used to transfer DMX signal to a DMX power pack or dimmer.
8. Power Input Cord: Plug this cord into a matching power supply.

2. Operation Guide

2.1 Receive Mode

This function allows you to turn on and control the intensity of the fixture with the use of a DMX controller or MIDI sequencer. On, off and dimming functions can be performed through this pack. This dimmer has 4 individual DMX address, DMX fail mode allows you to assign output when DMX signal is interrupted. You may also set your dimmer pack to function as 1,2,3 or 4 channel dimmer pack.

2.1.1 Receive Enable

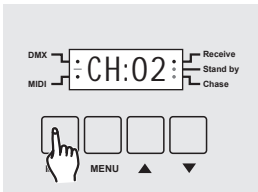

Tap the Mode button until the Receive LED in the Segment Display lights, indicating Receive mode is active.

When the unit is receiving a DMX signal, the DMX LED will blink in the Segment Display indicating a DMX signal is present.

When the unit is receiving MIDI signal, the MIDI LED will blink in the Segment Display indicating MIDI signal is present.

2.1.2 MIDI Channel

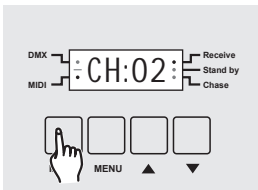

1. Enter Receive mode, the Segment Display shows "CH" followed by two numbers(01-16).

2. Operation Guide

2.1.2 MIDI Channel

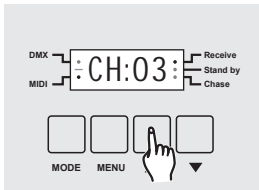

2. Tap the Up or Down button to select MIDI channel from CH 01-16. Make sure your MIDI channel matches that on the MIDI sequencer.

2.1.3 Note Number

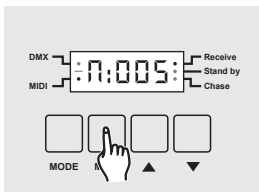

1. Enter Receive mode. Tap the Menu button until the Segment Display shows Note Number.

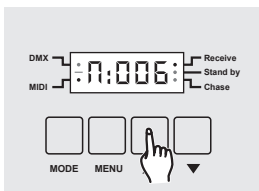

2. Tap the Up or Down button to select desired Note Number from 1-128.

2. Operation Guide

2.1.4 DMX Fail mode

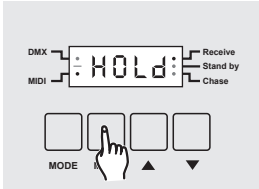

1. Enter Receive mode, tap MENU until the Segment Display shows HOLD/ OFF/ ON. DMX fail mode allows you to set the output when DMX signal is interrupted.

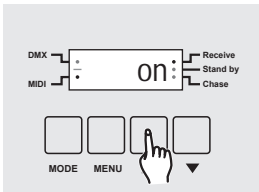

2. Tap UP/DOWN to change between HOLD, OFF and ON.

[HOLD]: the last DMX setting is held in the outputs.
[OFF]: output is switch off.
[ON]: output is full on.

2.1.5 Channel DMX Address

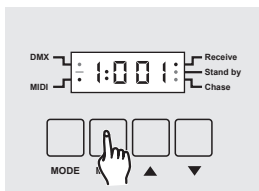

1. Enter Receive mode.
2. tap MENU until the Segment Display shows DMX address, DMX LED lights up.

2. Operation Guide

2.1.5 Channel DMX Address

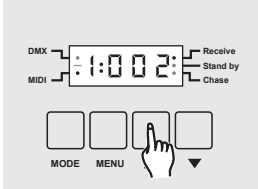

3. Tap UP/DOWN to select DMX address from 001-512 for the channel.
4. Continue steps 2-3 until each of the four channels has a DMX address.

2.1.6 1CH./ 2CH./ 4CH. Dimmer Pack

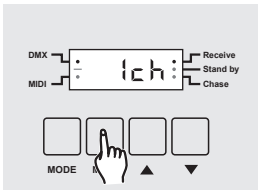

1. Enter Receive mode.
2. tap MENU until the Segment Display shows channel output mode, this mode allows you to set your dimmer pack to function as a 1,2, 4 channel DMX dimmer pack.

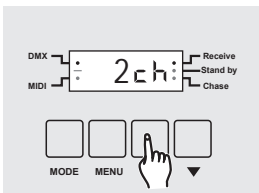

3. Tap the Up or Down button to change between 1ch/ 2ch/ 4ch.

[1ch]: all four channel output is controlled by the first DMX channel.

[2ch]: channel one and two are controlled by one DMX channel, channel three and four are controlled by another DMX channel.

[4ch]: each of the four channels is controlled by one DMX channel.

2. Operation Guide

2.2 Chase Mode

If you set 4 channel output for this dimmer, this unit can be used as a 4 channel chaser. This function allows you to select any of these 16 built-in programs or set the pack to chase as desired to get a more dramatic light show. You may control the speed at which the programs will chase.

2.2.1 Chase Enable

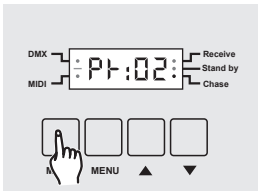

Tap MODE until the Chase LED in the Segment Display lights, indicating Chase mode is active.

2.2.2 Chase Program

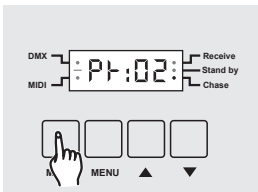

1. Enter Chase mode, the Segment Display shows the chase program.
When the Segment Display shows "Pr" followed by two numbers or "AU", any program selected will chase instantly.
When the Segment Display shows "PF" followed by two numbers or "AU", any program selected will fade or glide between chase steps instead of instantly changing. The rate of the change is adjusted by the time between steps(chase speed).

[AU]: each of the 16 programs will be executed eight times in sequence.

2. Operation Guide

2.2.2 Chase Program

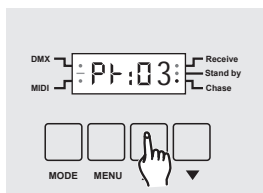

2. Tap UP/DOWN to select from 1-16 programs.

2.2.3 Chase Effect

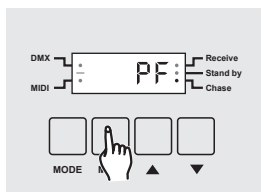

1. In Chase Mode, tap MENU until Chase Effect is activated.

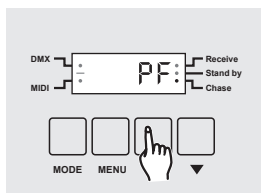

2. Tap UP/DOWN to change between Pr and PF.

NOTE:

When this unit is set to function as a switch pack, the programs will chase without fade-in or fade-out. Only when this unit serves as a dimmer pack, you can set the programs to fade in or fade out.

2. Operation Guide

2.2.4 Chase Speed

1. Enter Chase mode.
2. Tap the Menu button until the Segment Display show "SP" followed by two numbers.

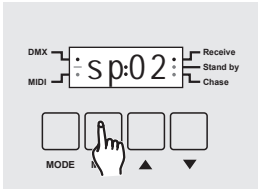

2. Tap UP/DOWN to select desired chasing speed. The value 01 will give the slowest speed, and the value 99 will give the fastest speed.

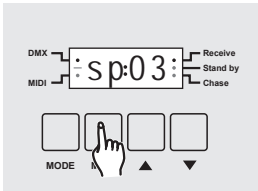

2.2.5 4 Channel Chaser

1. Enter Chase mode.
2. tap MENU until the Segment Display shows channel output mode.

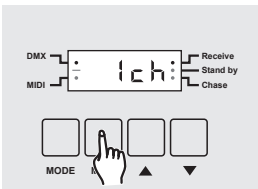

2. Operation Guide

2.2.5 4 Channel Chaser

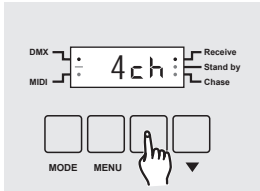

2. Tap UP/DOWN to select 4ch mode. The programs will chase only when this unit serves as a 4 channel chaser.

2.3 Dimmer pack/Switch pack

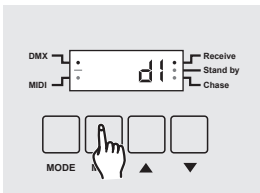

1. In Receive or Chase mode, tap MENU until the Segment Display shows "DI" or "SI".

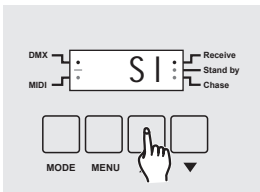

2. Tap UP/DOWN to change between "DI" and "SI".
If "DI" is selected, this unit serves as a dimmer pack, you may adjust the intensity of each of four channel, the programs will fade in or fade out if Chase effect is active.
If "SI" is selected, this unit serves as a switch pack, you can only turn on or off the output and the programs will chase instantly.

2. Operation Guide

2.4 Channel Dimmer Limit

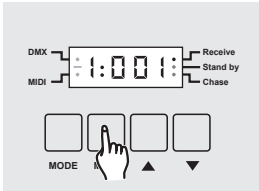

1. In Receive or Chase mode, tap MENU until the Segment Display shows channel dimmer limit, DMX LED will be off or flash.

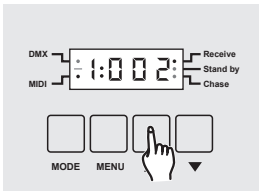

2. Tap UP/DOWN to adjust the value between 000-100. Once the value is selected, the maximum dimmer will be defined.
3. Continue steps 2-3 until you've set limit of maximum dimmer of each of the four channel.

2.5 Remote Type

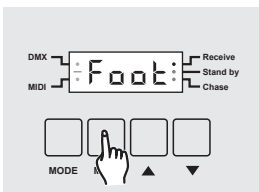

1. In Receive or Chase mode, tap MENU until the Segment Display shows "FOOT" or "RF" .

2. Operation Guide

2.5 Remote Type

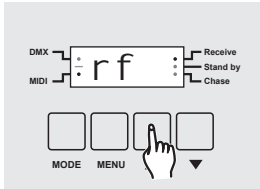

2. Tap UP/DOWN to change between FOOT and RF modes.
If FOOT is selected, a foot control(sold separately) is used to control this unit.
If RF is selected, a detector and a RF control(sold separately) are required to be used.

Additional information: How to use RF control?

1. Turn off the unit's power.
2. While pressing MODE, apply power to this unit.
3. Tap any button on the RF control in five seconds, the RF control is chose to serve this unit.
4. Repeat steps 1-2 to deselect the RF control.

3. Technical Specifications

Power Input	AC 120V ~ 50-60Hz, 20A max.
Channel Output	5A/CH., Total 20A max.
Channel Fuse	F6A 250V 5x20mm
DMX In/Out	3-pin XLR male & female socket
MIDI In/Thru	5-pin multi socket
Dimensions	8.3" x 10.4" x 3.0" (212x188x71mm)
Weight	8 lbs (3.6 Kg)

